

11

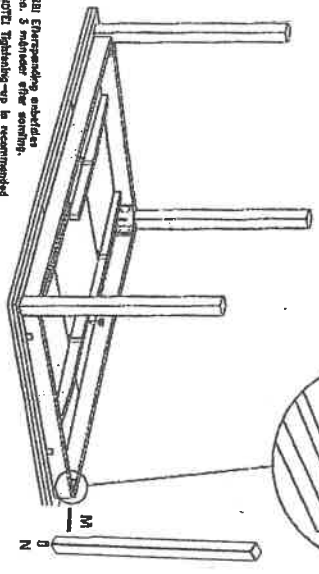

NIU Erweiterungsbeinchen
ca. 5 Minuten ohne Bohren.
NOTIZ: Tightening up is recommended
approximately 3 months after assembling.

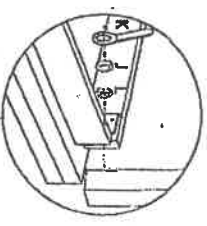
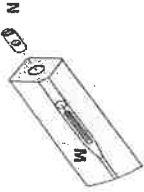

4

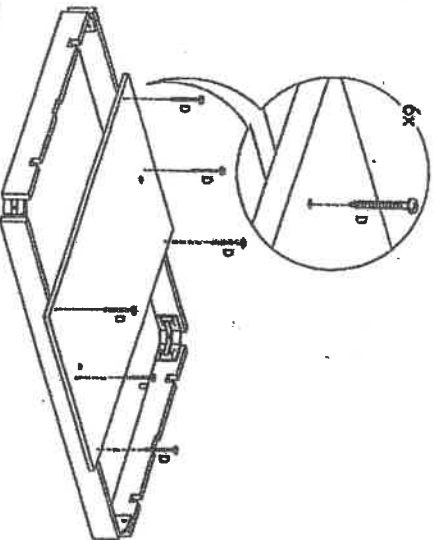



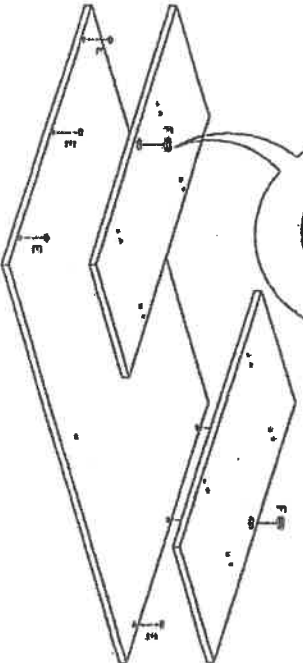
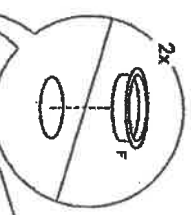



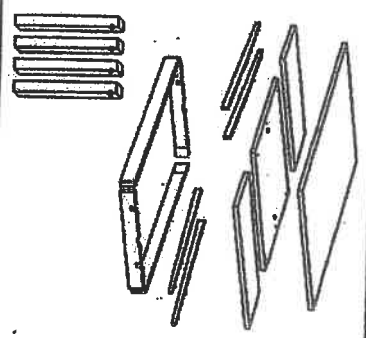
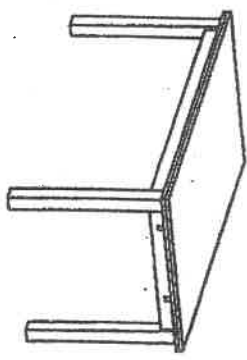
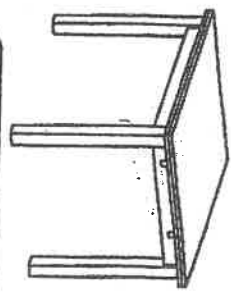





5



NR. 110 / 112 / 120 / 122 / 128
 SPISEBORD / DINING TABLE



- 4 x A 
- 32 x B 
- 4 x C 
- 14 x D 
- 10 x E 
- 2 x F 
- 2 x G 
- 4 x H 
- 1 x I 
- 4 x J 
- 1 x K 
- 4 x L 
- 4 x M 
- 4 x N 